

Using System Dynamics modeling to forecast China's population until 2060 to visualize the aging and shrinking population trends

Abstract

According to UN records China has been the most populous country on earth since 1950; however, this trend is expected to change in 2023. At the end of 2022, the population of China stood at 1.41175 billion, a decrease of 850,000 compared to the population at the end of 2021. This is notable because it is the first time China's population has seen negative growth since 1961. China's death rate has surpassed its birth rate. For this reason, it is important to investigate the size and speed of the population shift. Using System Dynamics modelling, we estimate the future size of China's population, the future size of the workforce, the future population structure, and the burden the workforce will bear to financially support non-working people over 65 years old (China Pension System). We hope that our modelling can contribute to the creation of sound policies so that China can meet its development goals.

Problem

It is urgent to quantify China's demographic change as described above. The knowledge gained from this study can help shape policy to prepare for future changes. In particular we have designed our model to answer the following four questions about the years 2000 to 2060:

- 1 What will be the population of China?
- 2 What will be the size of China's workforce?
- 3 What will be the demographic structure of China's population?
- 4 What will the dependency burden be on the workforce?

An aging population is known to present risks to not only national but global prosperity in not only economic, but also social and political realms (Klaus Schwaab, World Economic Forum, 2012). China has been the most populous country on earth for generations, and more and more through globalization the world relies on China's production capabilities. Since 2010 China has had the second highest GDP in the world, and accordingly is and has been a major player in the world economy. However, China's demographics are changing. The changes in the age structure in a country, demographic change, can have a profound impact (Tscheuschner, 2020), such as on the size of available workforce, and, related to this, the burden that the shrinking workforce must bear to support an aging population.

In Figure 1 we can observe that the crude birth rate has fallen dramatically since the early 1960s, and that while life expectancy at birth (LEXP) has been steadily climbing each year, the crude death rate has remained virtually flat. Notwithstanding, the crude death rate surpassed the crude birth rate at the end of 2022. This will result in an aging population in China, a demographic group which is climbing steadily. Needless to say, with a steadily increasing aging population, China's huge workforce is expected to decrease.

The status of work that has been done so far

We have created an original System Dynamics model, and within that we built 3 sub-models with many variables to get a full picture of China's present and future population trends with the end focus on the viability of China's pension system. In particular, we have used the data produced by the model to create dependency ratios to get a clearer picture of the size of the burden that working people will bear to support non-working people over 65 who are expected to live longer and longer.

Dynamic hypothesis

Our working hypothesis is that China's population which is widely believed to have reached a peak, will be followed by a gradual decrease that will result in a shrinking workforce. Through System Dynamics modeling we are attempting to quantify the extent of the imbalance between workforce and retired people in China. This information can be used to help shape policy.

A description of the intended approach & model structure

We have designed and built three System Dynamics models: a simple population model, an array population model, and a workforce model. Our simple population model (Figure 2), includes 1 stock and 7 variables, to calculate the overall population level, and we cross check with our array population model from 2000 to 2060. We use a TFR sub model in the array population model as seen in Figure 3 to calculate births. We have established three different scenarios for total fertility rate (TFR), categorized as low, middle, and high. The array population model divides population stock into 42 groups by age and gender. We have used 5-year age cohorts, meaning that we have grouped the population into 21 five-year age groups for both males and females. We consider many aspects of population: births by gender and aging in, by age and gender, are inflows. Aging out, deaths, and net immigration, all by age and gender, are outflows. As seen in Figure 4 we use two array stocks which include 84 stocks (one is a shadow array stock). Our most important variables here include workforce participation rate, the size of the workforce, and non workers over 65. We use this model to calculate the ratio of non workers over 65 to the workforce in China from 2020 to 2060 (the dependency burden).

Preliminary results

As seen in Figure 5 the total population continues to increase, yet the gap between total births and total deaths narrows until 2022 when divergence between total deaths and total births occurs. At that point the natural increase is zero, and the total population starts to drop faster and faster.

As seen in Figure 6, there is one simple population model presented along with three different TFR scenarios derived through array modeling, each exhibiting an overall trend of reaching a population peak in a specific year, followed by a decline (with varying rates of decrease).

As seen in Figure 7, the pyramid on the left is historical data from 2000, and the pyramid on the right is the end stage of the modeled projections applying a low TFR scenario until 2060. The gender balance will continue to favor males; however, the age distribution will change significantly. In 2000, most of the population was under 50. In 2060 most of the population will be 50 years old and above. The population of women of child-bearing age will decrease significantly. A dramatic difference is seen in the population of 65+ when comparing 2000 and 2060. Because the 2060 pyramid is top heavy, we can easily see the burden of the younger population to support the older population.

As seen in Figure 8, the workforce is expected to continue to have a trend of rise and fall. Because in China's pension system, workforce monetary contributions support non workers over 65, we can see that the potential for contributions quickly diminishes and presents perhaps an impossible burden after 2030.

As seen in Figure 9, in 2000, there were about 12 workers to support one non working person over 65. After 2000, there was a sudden drop in the numbers of workers that support the non working over 65. As we can see in 2015, the workers had already been reduced by about 50%; fifteen years later, we expect the workers will be cut by approximately 25% more. In 2060, we expect fewer than 2 workers to be supporting each non worker. The dependency burden rises accordingly, as shown by the blue line as the burden on the workforce grows. The burden on the workers to support the non working

over 65 can be expressed as a dependency ratio which is $\frac{\text{Non workers over 65}}{\text{Workforce}}$.

Data Sources and Software

We are using Stella Architect V3 from iSeeSystems to build the SD model in this Work-In-Progress(WIP). To construct the SD, we have utilized various data sources, including the World Bank Indicators data on Total Fertility Rate (TFR) spanning from 2000 to 2020, the Fifth, Sixth, and Seventh National Population Census of the People’s Republic of China for Crude Death Rate (CDR), sex ratio, total population in 2000, and the population of 42 age and gender groups in 2000. Additionally, we have incorporated data from the United Nations on Crude Birth Rate (CBR), CDR, net immigration rate, and Chen's paper (2022) on three scenarios of TFR from 2000 to 2060. To estimate workforce participation rate, we have referred to Ma's paper (2010).

Appendix

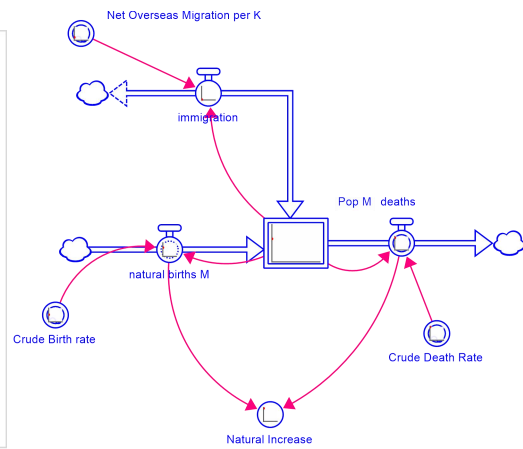
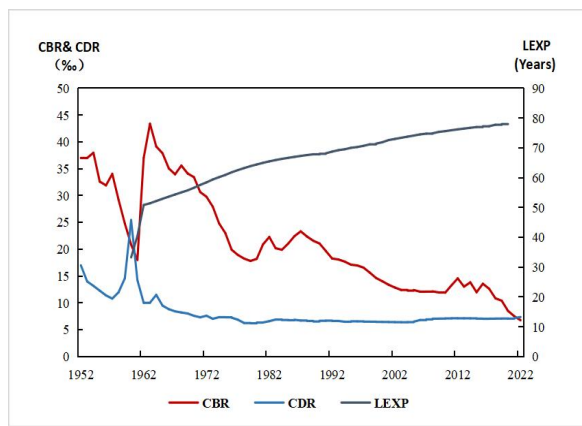
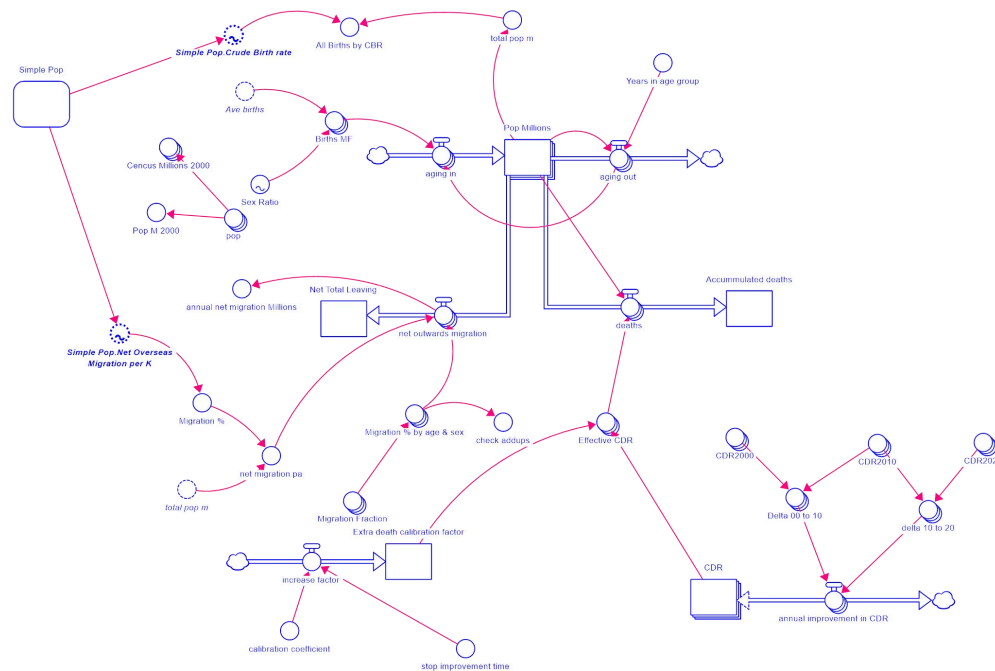

Figure 1 (left) Crude birth rate (CBR), crude death rate (CDR) and life expectancy at birth (LEXP) for China 1960 to 2020

Figure 2 (right) Simple population model



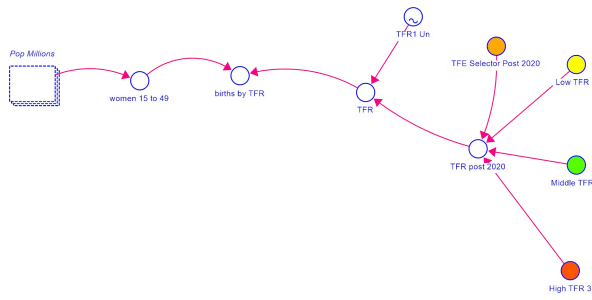

Figure 3 Array population model

Note: Aging in and aging out refers to when an individual leaves one age group and enters the next one. We designed the age groups ourselves.

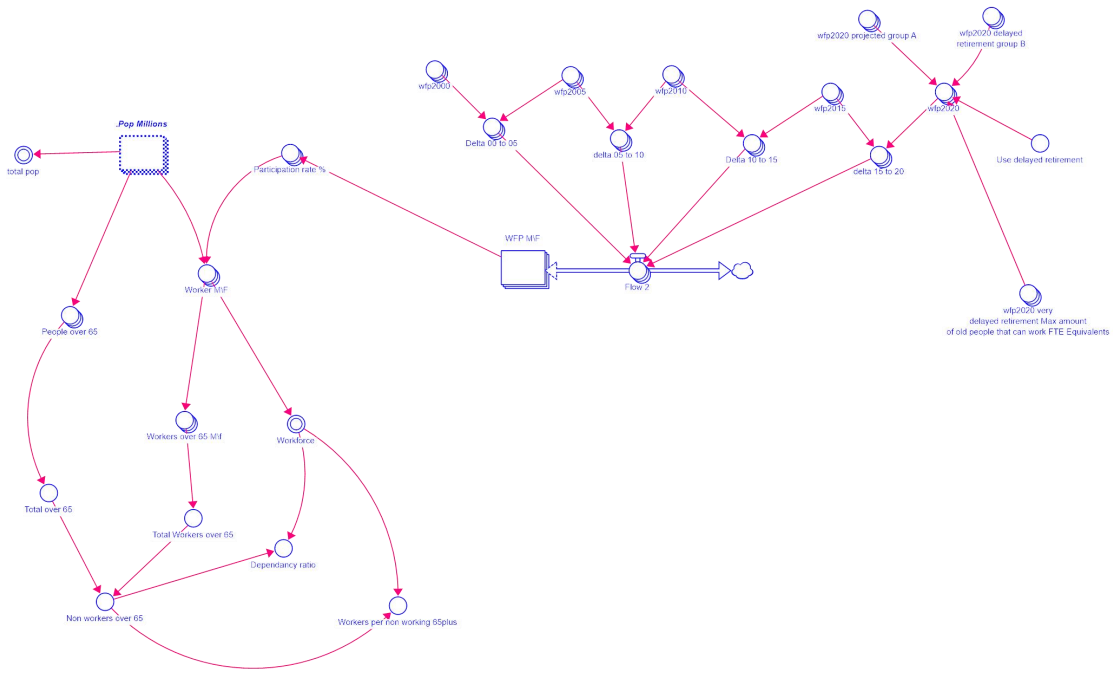

Figure 4 Workforce model

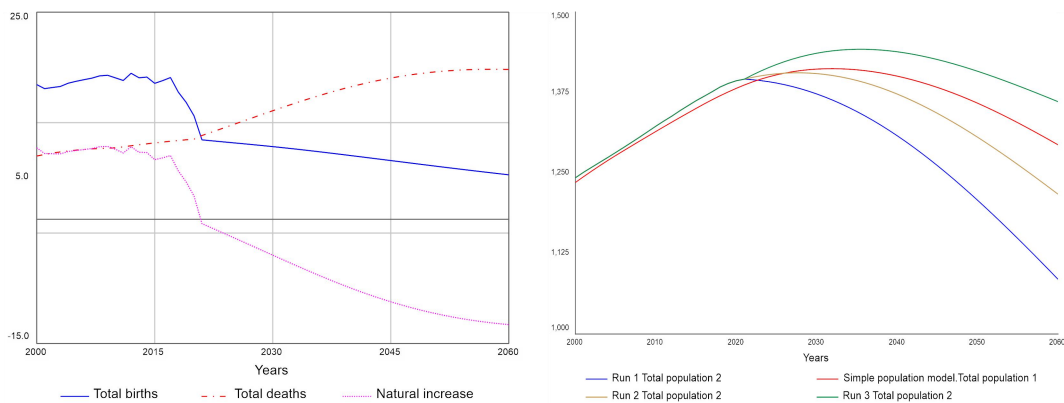

Figure 5(left) Total births, total deaths, and natural increase for China using a low TFR scenario from 2000 to 2060

Figure 6(right) Projection of total population under different scenarios(need an English version)
 Note: the vertical axis is measured in millions of people. Run1 represents a low TFR scenario, Run2 represents a middle TFR scenario, and Run3 represents a high TFR scenario.

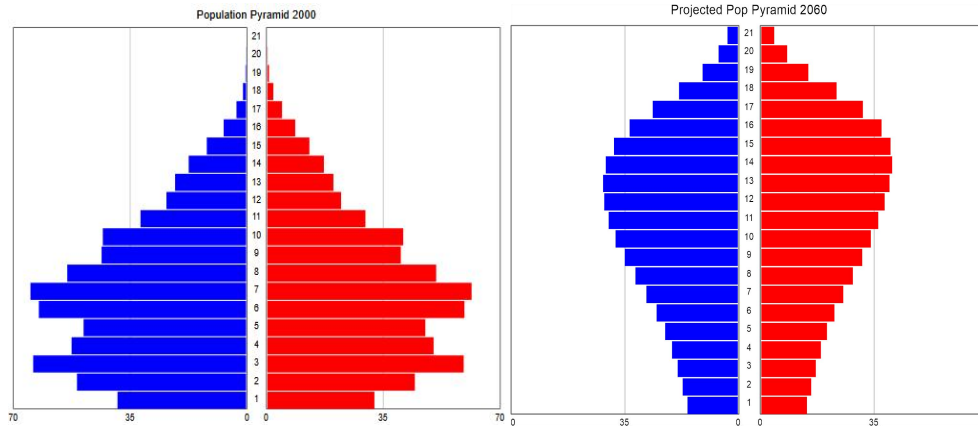

Figure 7 Population Pyramid 2000 historical data (left), projected Population Pyramid 2060 using a low TFR scenario (right)

Note: Blue is males; Red is females. Each bar from 1 to 21 represents 5 years. For example bar 1 represent new born to 4.99 years.

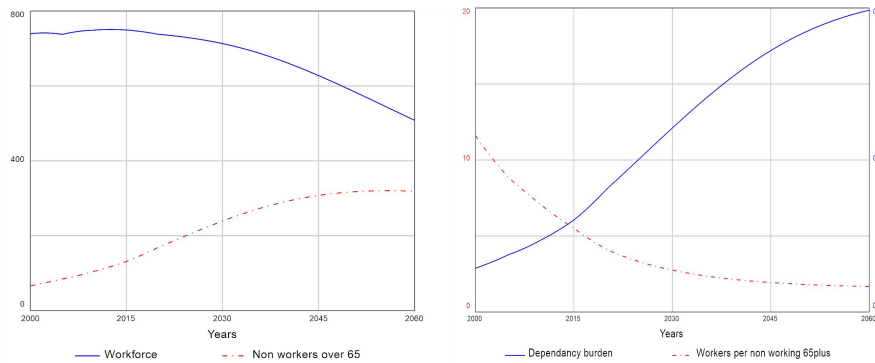

Figure 8 (left) Workforce and non-workers over 65 for China using a low TFR scenario 2000 to 2060

Figure 9 (right) Dependency burden and workers per non-working 65+ using a low TFR scenario

References

- Chen Wei.(2022).Prediction of Negative Population Growth and Aging Trend in China. *Social Science Journal*(05),133-144(in Chinese).
- Chinese census, 2000,2010,2020. National Population Census of the People's Republic of China. <http://www.stats.gov.cn/tjsj/pcsj/> (Accessed 12 November 2022) accessed on.
- Guo, A., Ding, X., Zhong, F., Cheng, Q., & Huang, C. (2019). Predicting the future Chinese population using shared socioeconomic pathways, the sixth national population census, and a PDE model. *Sustainability*, 11(13), 3686.
- Ma Z, Lv Z & Ye K.(2010).Labor participation rate and labor force growth: 1982-2050. *Chinese Journal of Population Science* (01),11-27+111(in Chinese).
- Tscheuschner, P. (2020). Essays on demographic change and R&D-based economic growth.
- World Bank, 2022. World development indicators. <https://data.worldbank.org/> indicator. (Accessed 12 December 2022) accessed on.
- World Economic Forum (2012). Global Population Ageing: Peril or Promise. Available at: <https://www.weforum.org/reports/global-population-ageing-peril-or-promise>.
- Wu, P., Wu, Q., & Dou, Y. (2017). Simulating population development under new fertility policy in China based on system dynamics model. *Quality & Quantity*, 51(5), 2171-2189.
- United Nations(2022). World Population Prospects. <https://population.un.org/wpp/DataSources/> (Accessed 12 December 2022) accessed on.